

Vera Cruz Road Bridge (SR 2027)

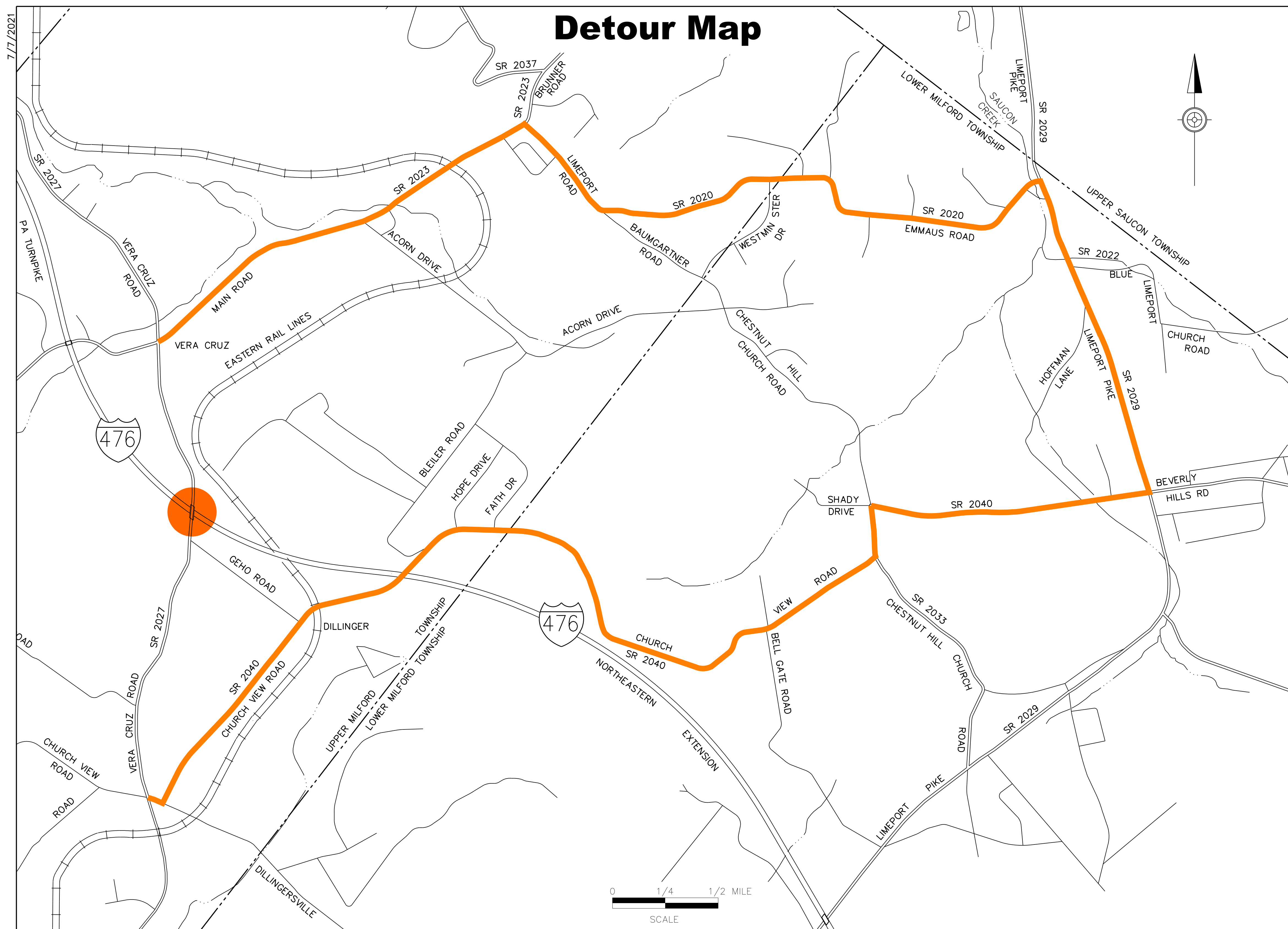

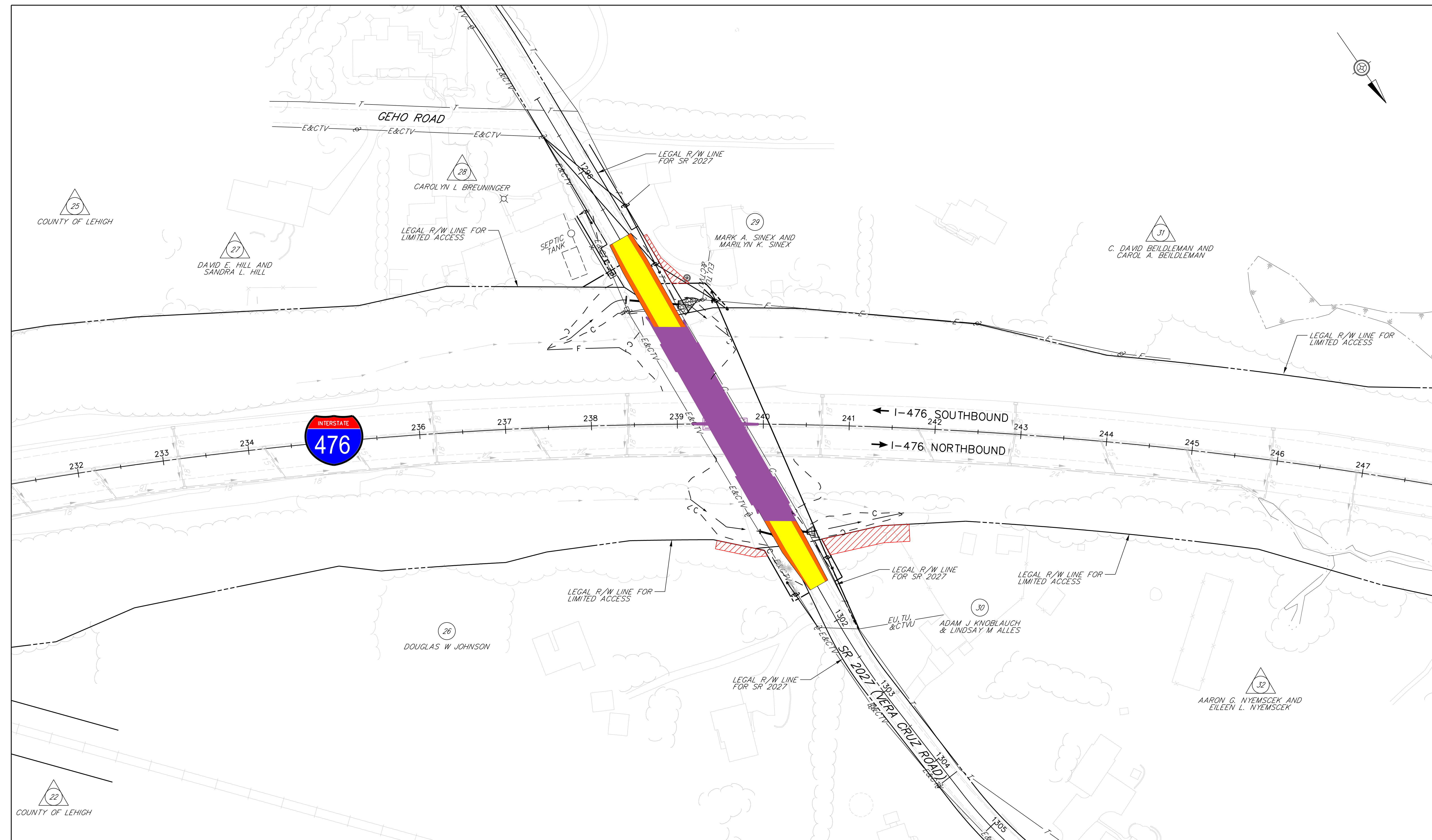





Detour Map



Legend

-  WORK AREA
-  PROPOSED DETOUR ROUTE (7.8 MILES)

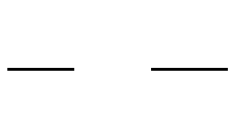
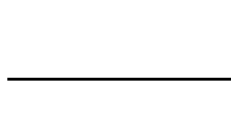
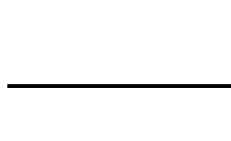
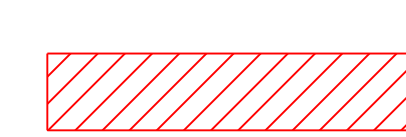
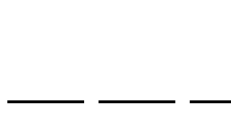
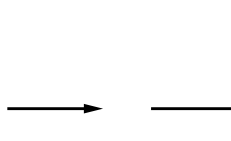
Legend

-  PROPOSED ROADWAY
-  PROPOSED SHOULDER
-  PROPOSED BRIDGE
-  PARCEL - (AFFECTED)
-  PARCEL - (NOT AFFECTED)
-  PROPOSED CUT LINE
-  PROPOSED FILL LINE
-  LEGAL RIGHT-OF-WAY LINE
-  TEMPORARY CONSTRUCTION EASEMENT
-  DRAINAGE SYSTEM
-  PROPOSED CHANNEL CENTERLINE
-  EXISTING RIGHT-OF-WAY FENCE
-  PROPOSED RIGHT-OF-WAY FENCE

Anticipated Project Timeline

- ADVANCED UTILITY LOCATIONS: JULY 2021
- BID PROJECT: OCTOBER 2021
- BEGIN CONSTRUCTION: JANUARY 2022
- BEGIN DETOUR: JANUARY 2022
- END DETOUR: NOVEMBER 2022
- COMPLETE CONSTRUCTION: NOVEMBER 2022

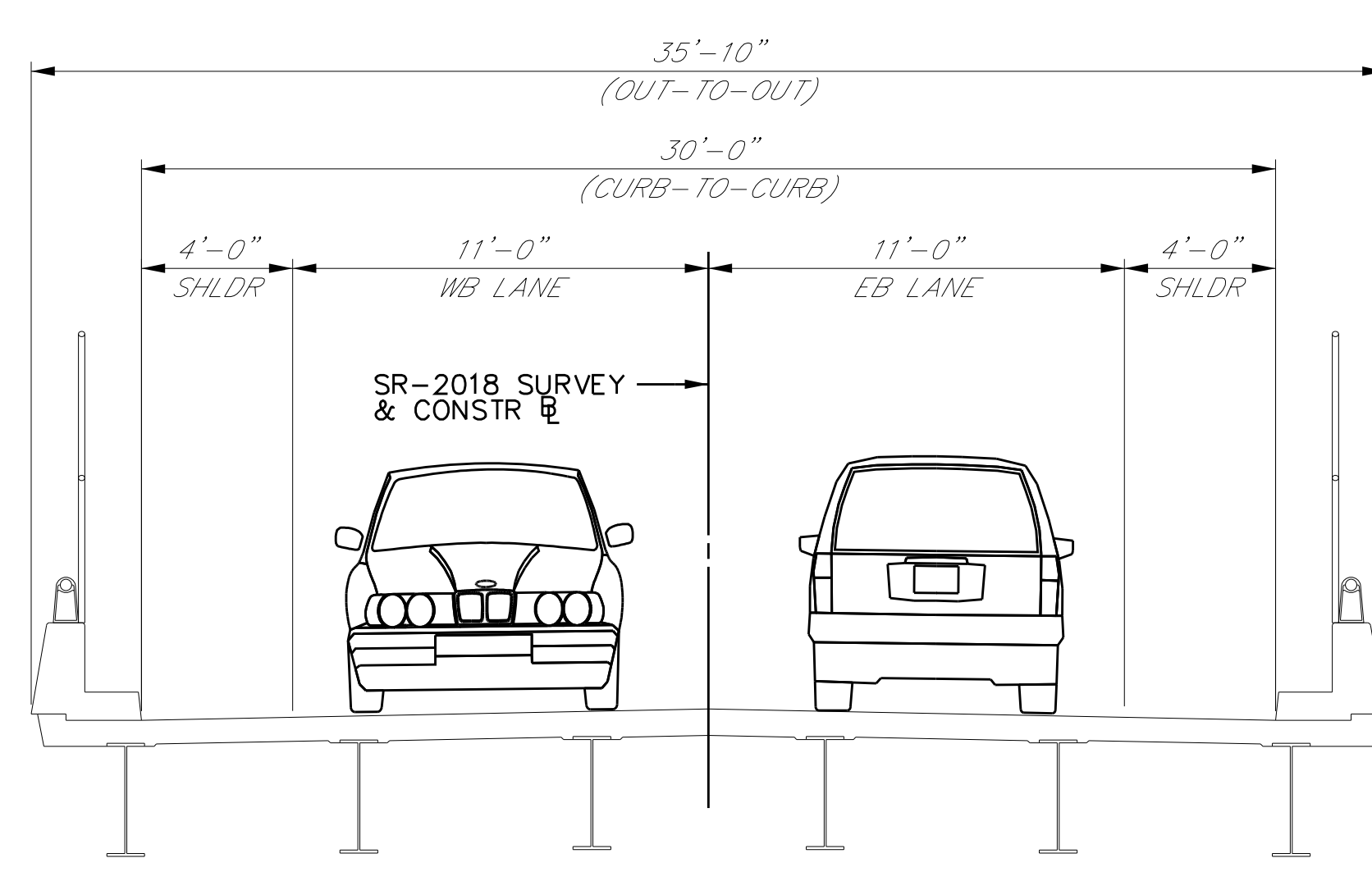

Vera Cruz Road Existing Bridge Typical Section

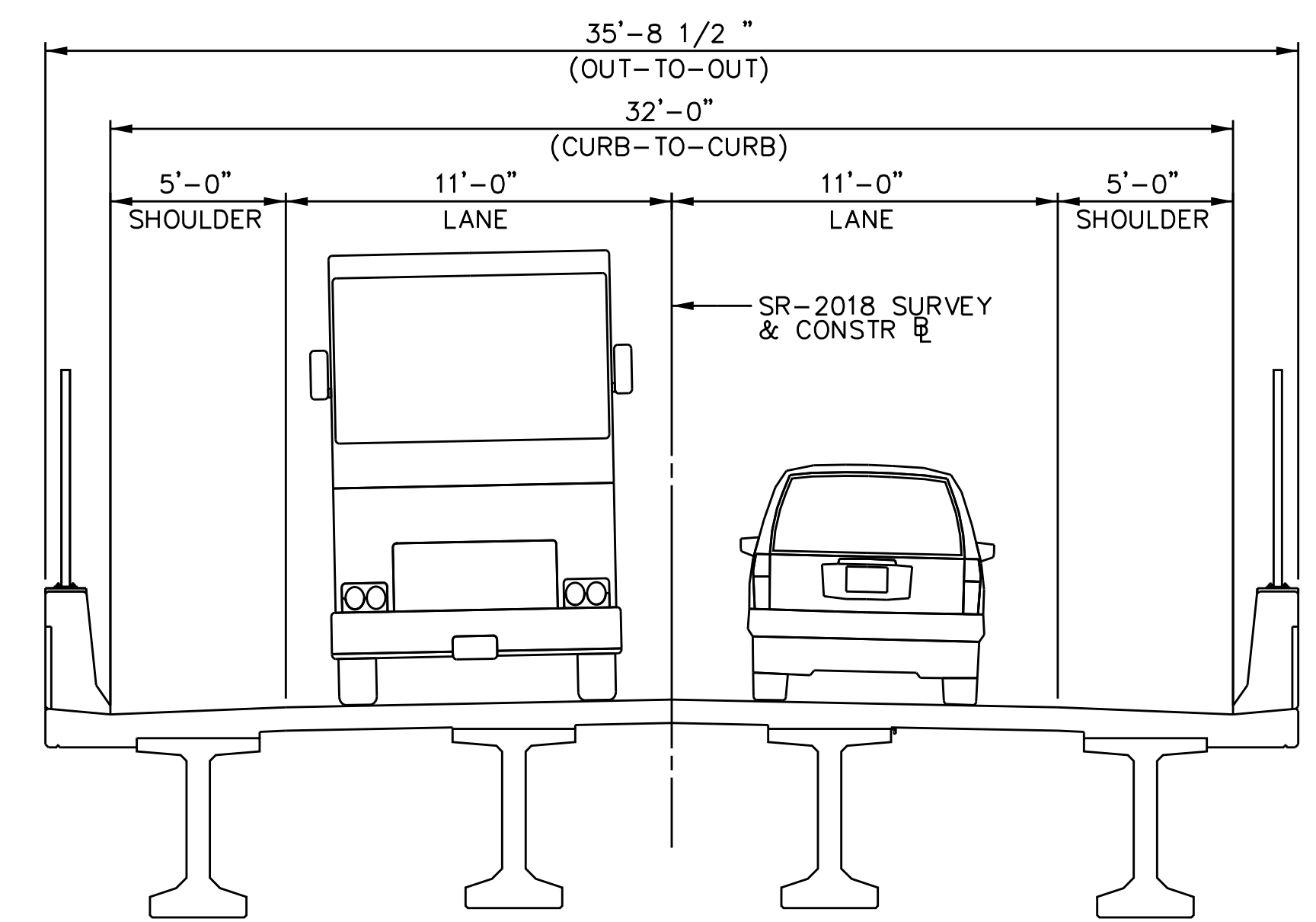

Vera Cruz Road Proposed Bridge Typical Section

