

MPT-10
1.5" Border With 5.0" Radius
Black on Orange

8" LET. (SERIES D)	8" LET. (SERIES D)	8" LET. (SERIES D)
12.5 -	34.0 -	8.9 -
6.4 - T	8.2 - A	6.9 - C
7.5 - O	7.2 - R	7.5 - O
6.4 - L	5.9 - E	7.3 - N
4.8 - L	6.7 - A	6.8 - S
12.0 -	34.0 -	6.4 - T
7.3 - P	96.0	7.3 - R
5.4 - L		7.2 - U
8.1 - A		6.4 - C
6.4 - Z		6.4 - T
6.7 - A		3.1 - I
12.5 -		7.5 - O
96.0		5.4 - N
		8.9 -
		96.0

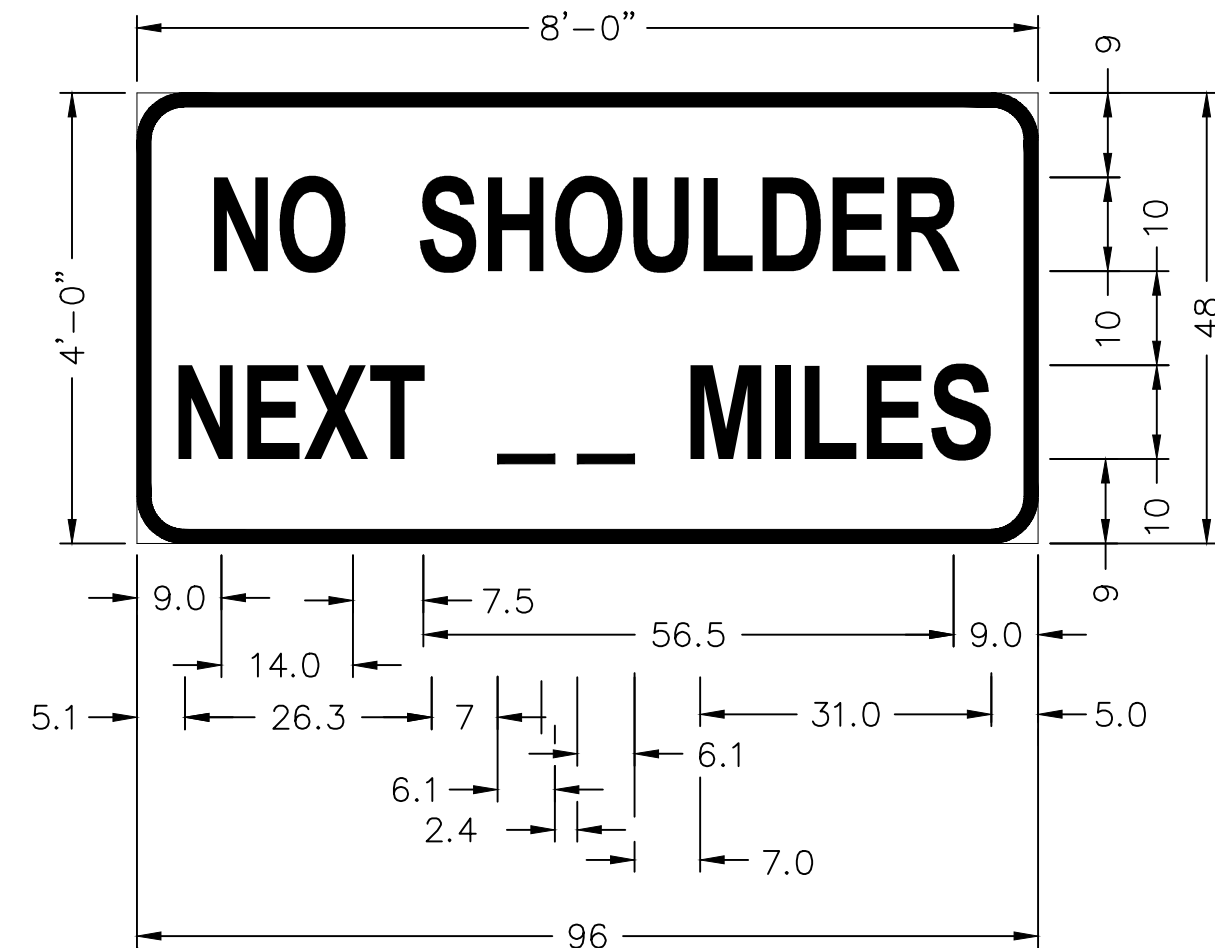

MPT-31
1.5" Border With 5.0" Radius
Black on Orange

10" LET. (SERIES C)	10" LET. (SERIES C)
9.1 -	5.7 -
7.5 - N	7.6 - N
5.8 - O	6.7 - E
7.5 -	7.0 - X
7.6 - S	5.0 - T
7.6 - H	*7.0 -
7.8 - O	13.3 -
7.6 - U	*7.0 -
6.7 - L	8.6 - M
7.6 - D	3.5 - I
6.7 - E	6.7 - L
5.4 - R	6.7 - E
9.1 -	5.5 - S
96.0	5.7 -
	96.0

* INDICATES MINIMUM SPACING

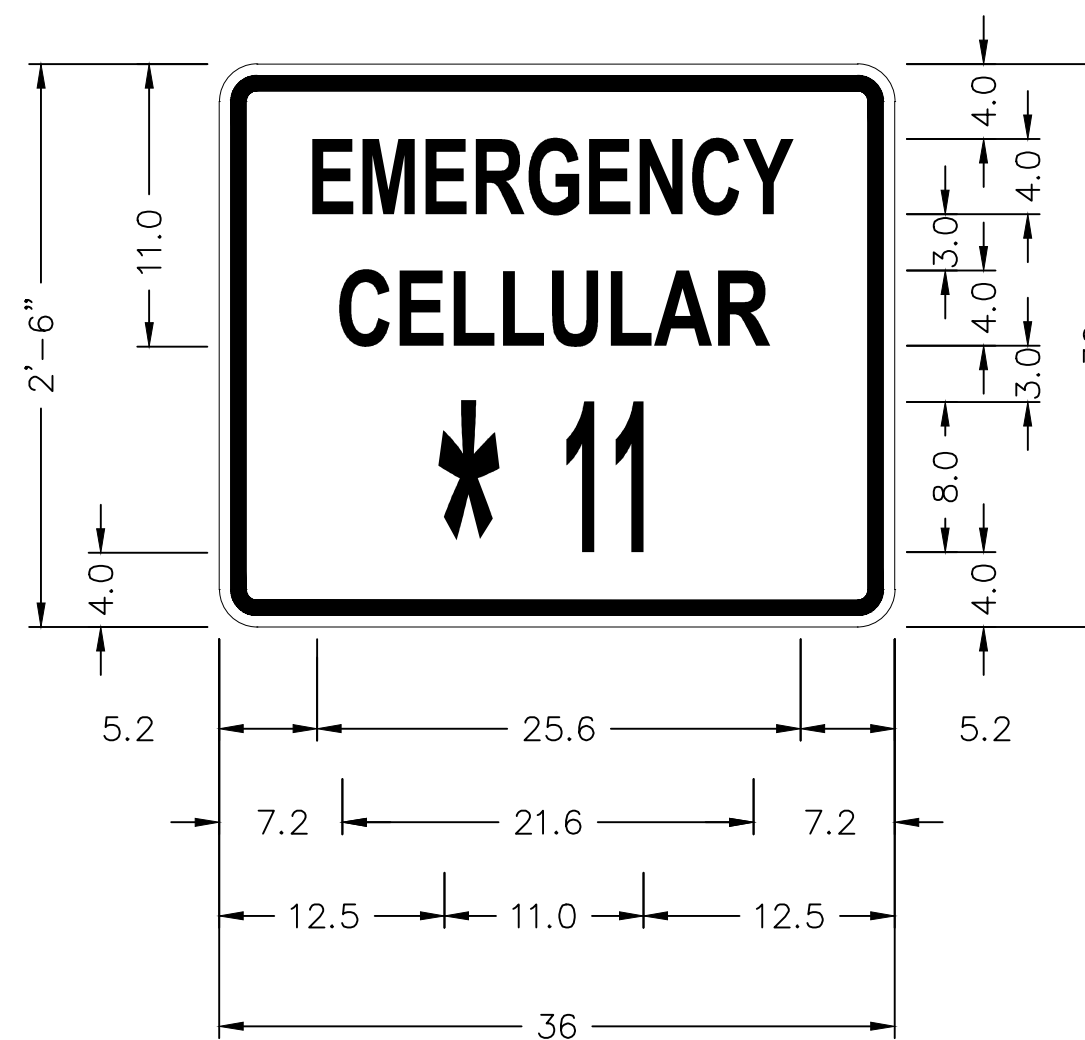

D12-14A
0.6" Margin With 0.8" Border
White on Blue
4" LET. (SERIES C)
8" LET. (SERIES C)

4" LET. (SERIES C)	4" LET. (SERIES C)	8" LET. (SERIES C)
5.2 -	7.2 -	10.0 -
2.7 - E	2.9 - C	11.0 - *
3.4 - M	2.7 - E	3.3 - 1
2.7 - E	2.7 - L	1.6 - 1
2.9 - R	2.6 - L	10.1 -
3.0 - G	3.1 - U	36.0
2.7 - E	2.2 - L	
3.0 - N	3.2 - A	
2.7 - C	2.2 - R	
2.5 - Y	7.2 -	
5.2 -	36.0	
36.0		

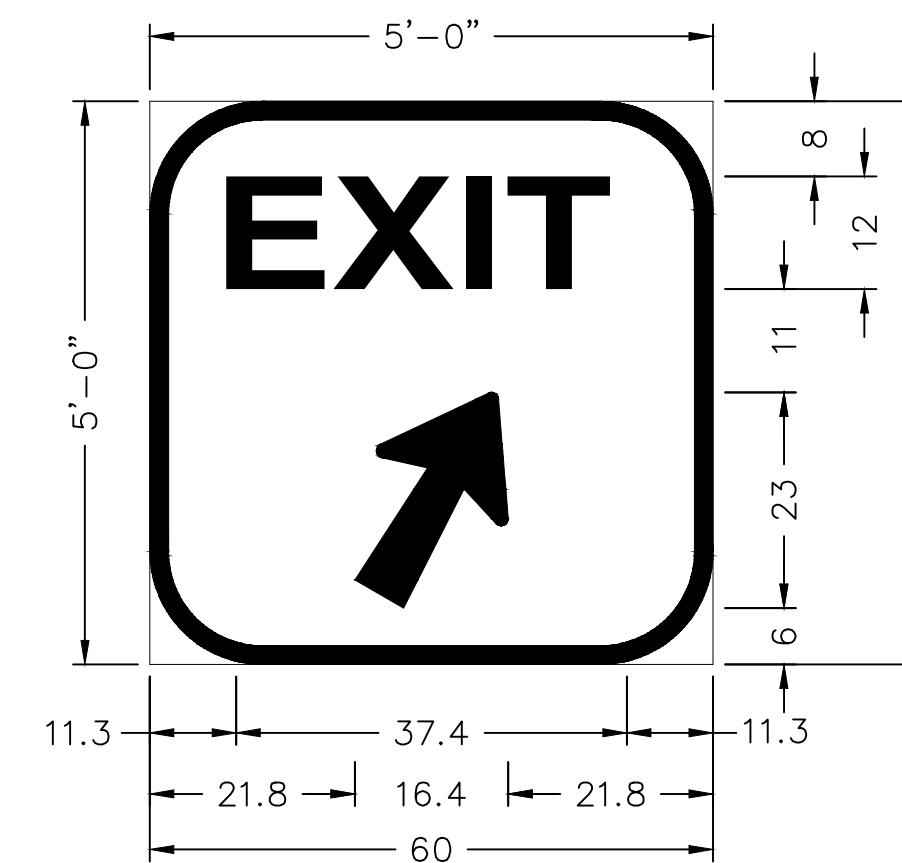

MPT-06
2.0" Border With 12.0" Radius
White on Green

12" LET. (SERIES E)	12" LET. (SERIES E)
11.3 -	21.8 -
11.3 - E	16.4 - ARROW
12.8 - X	21.8 -
4.5 - I	60.0
8.8 - T	
11.3 -	
60.0	

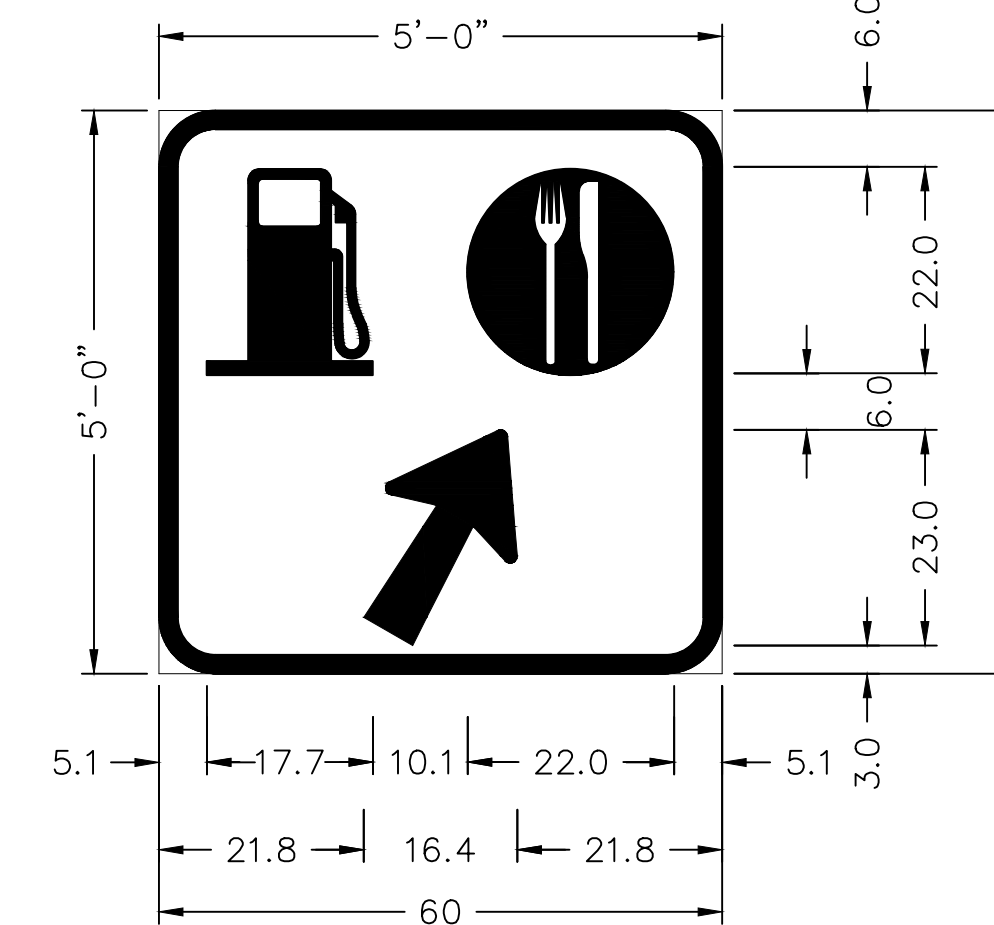

MPT-08
2.0" Border With 6.0" Radius
White on Blue

5.1 -	21.8 -
17.7 - FUEL	16.4 - ARROW
10.1 -	21.8 -
22.0 - FOOD	60.0
5.1 -	
60.0	

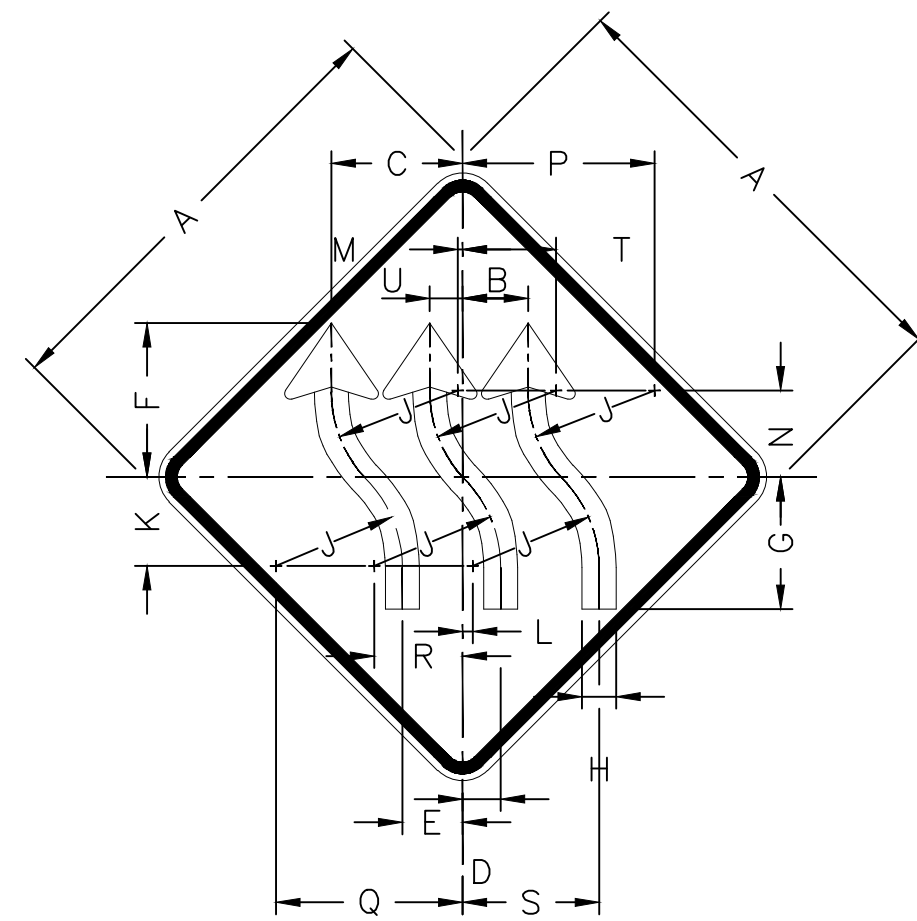

W1-4CL

SIGN SIZE	A	B	C	D	E	F	G	H	J	K	L
48X48	48	7	13 3/4	4 1/4	6 3/4	16 3/4	14	3 3/4	13 3/4	9 3/4	1 1/4

SIGN SIZE	M	N	P	Q	R	S	T	U	MARGIN	BORDER	BLANK STD.
48X48	1/2	9	20 3/4	19 3/4	9 3/4	14 1/2	10	3 1/2	3/16	1 1/8	B3-48

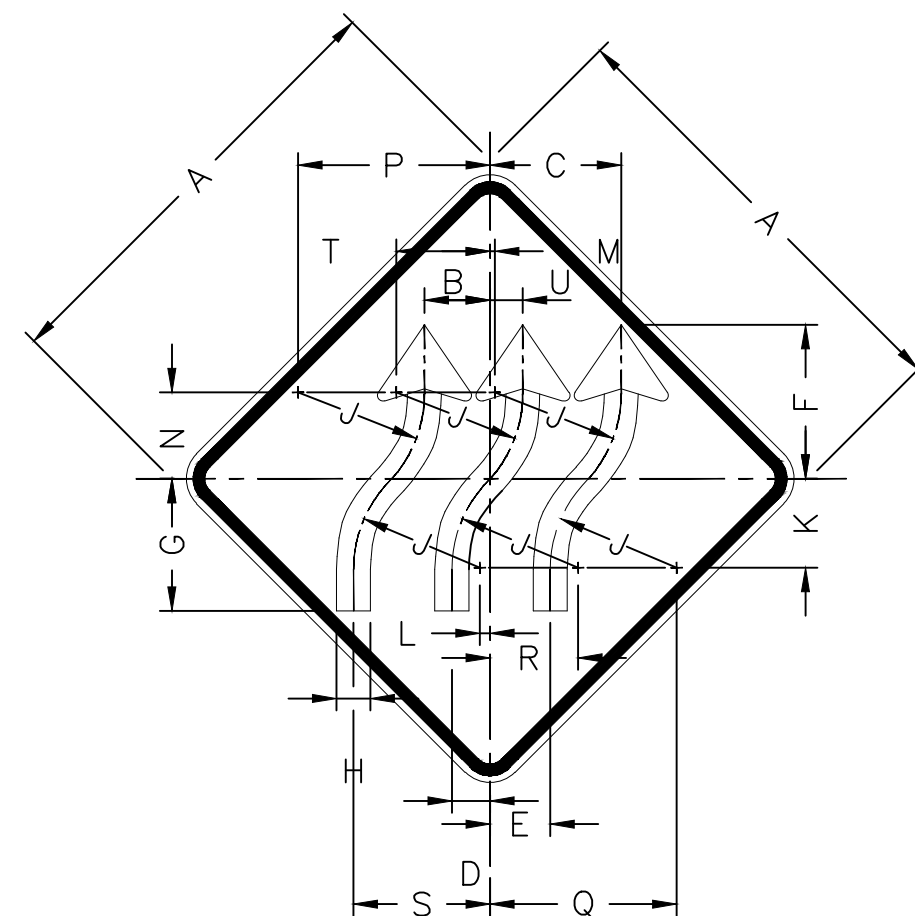

W1-4CR

SIGN SIZE	A	B	C	D	E	F	G	H	J	K	L
48X48	48	7	13 3/4	4 1/4	6 3/4	16 3/4	14	3 3/4	13 3/4	9 3/4	1 1/4

SIGN SIZE	M	N	P	Q	R	S	T	U	MARGIN	BORDER	BLANK STD.
48X48	1/2	9	20 3/4	19 3/4	9 3/4	14 1/2	10	3 1/2	3/16	1 1/8	B3-48

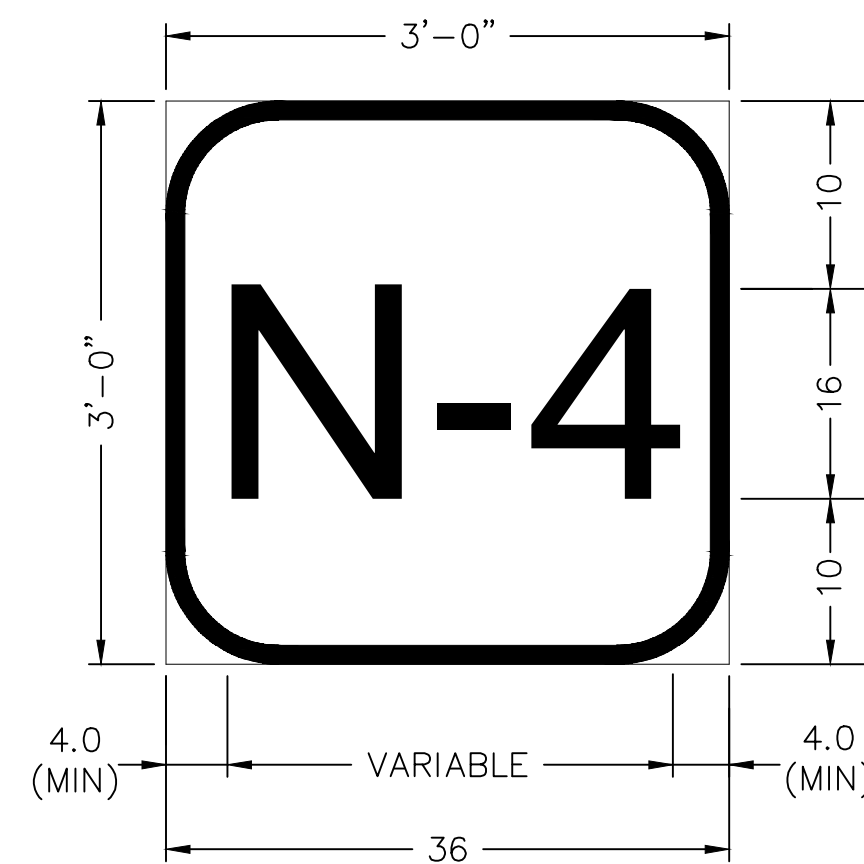

EPO ID

0.88" Border, 0.63" Indent, Black
Orange: "N-4", C 2K;

NOTE: THE LETTER AND NUMBER SHOULD BE CHANGED TO INDICATE DIRECTION OF TRAVEL AND NUMBER ID FOR EACH EMERGENCY PULL-OFF

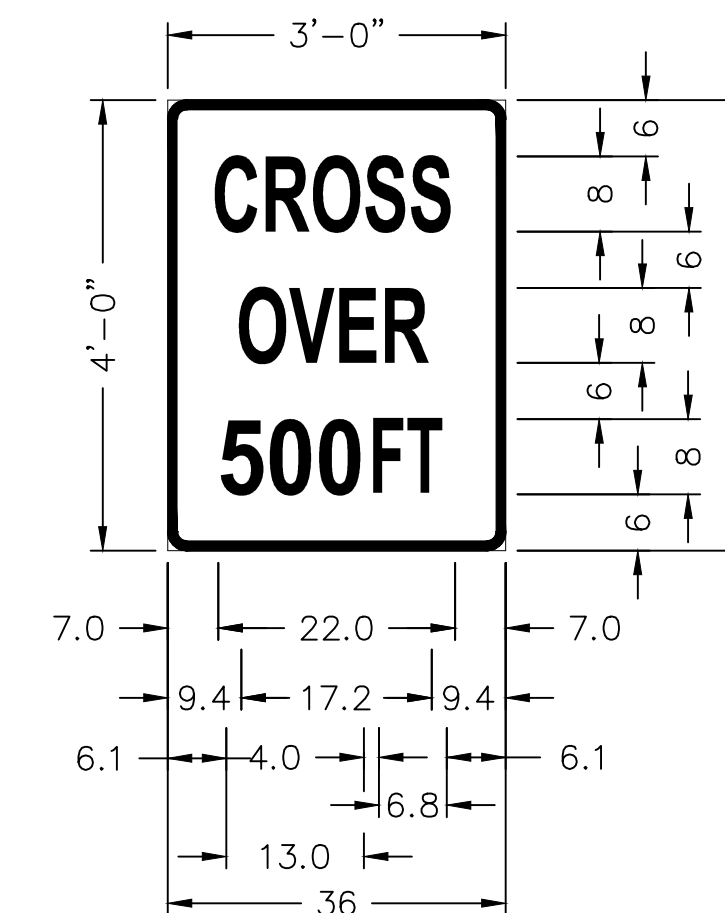

MPT-01

1.0" Border With 2.0" Radius
Black on Orange

8" LET. (SERIES B)	8" LET. (SERIES B)	8" LET. (SERIES B)
7.0 -	9.4 -	6.1 -
4.6 - C	4.8 - O	4.6 - 5
4.6 - R	4.9 - V	4.8 - 0
4.8 - O	4.2 - E	3.6 - 0
4.6 - S	3.3 - R	4.0 -
3.4 - S	9.4 -	3.8 - F
7.0 -	36.0	3.0 - T
36.0		6.1 -
		36.0

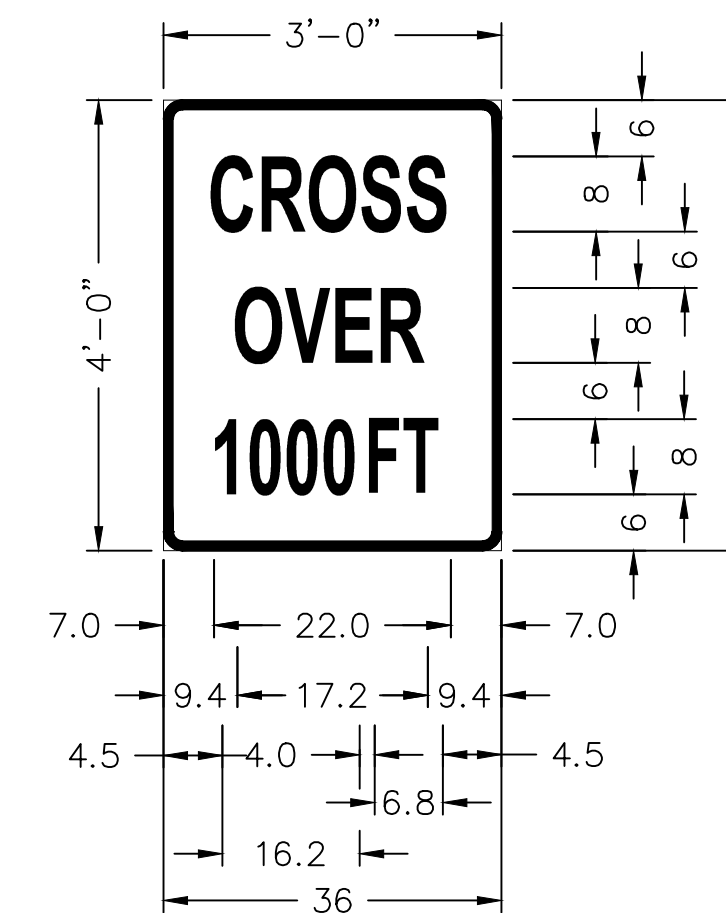

MPT-03

1.0" Border With 2.0" Radius
Black on Orange

8" LET. (SERIES B)	8" LET. (SERIES B)	8" LET. (SERIES B)
7.0 -	9.4 -	4.5 -
4.6 - C	4.8 - O	3.1 - 1
4.6 - R	4.9 - V	4.6 - 5
4.8 - O	4.2 - E	4.8 - 0
4.6 - S	3.3 - R	3.7 - 0
3.4 - S	9.4 -	4.0 -
7.0 -	36.0	3.8 - F
36.0		3.0 - T
		4.5 -
		36.0

NOTES:
1. ALL SIGN DIMENSIONS ARE IN INCHES, UNLESS NOTED OTHERWISE.
2. SIGN SHOWN IS NOT TO SCALE.

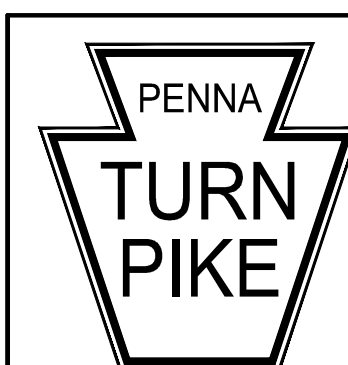

RECOMMENDED: MAY 3, 2024

ASSISTANT CHIEF ENGINEER - DESIGN

APPROVED: MAY 3, 2024

CHIEF ENGINEER

CONSTRUCTION AND MAINTENANCE
MAINTENANCE AND PROTECTION OF TRAFFIC
SIGN FABRICATION

PENNSYLVANIA TURNPIKE COMMISSION
STANDARD DRAWING

FILE NAME: PTS-960-1.dwg
DRAWING TYPE: 5A

SHEET 1 OF 5

DATE: APRIL 2024

PTS-960

PTC-TBRO

TRUCKS AND BUSES RIGHT LANE ONLY SYMBOL SIGN

- (a) Justification. The Trucks and Buses Right Lane Only Symbol Sign (PTC-TBRO) may be used in construction zones where it is required to restrict trucks and buses to the left lane because of insufficient lane width or shoulder depth.
- (b) Placement. When used, this sign should be erected in advance of and within construction zones where trucks and buses are required to stay in the right lane only.

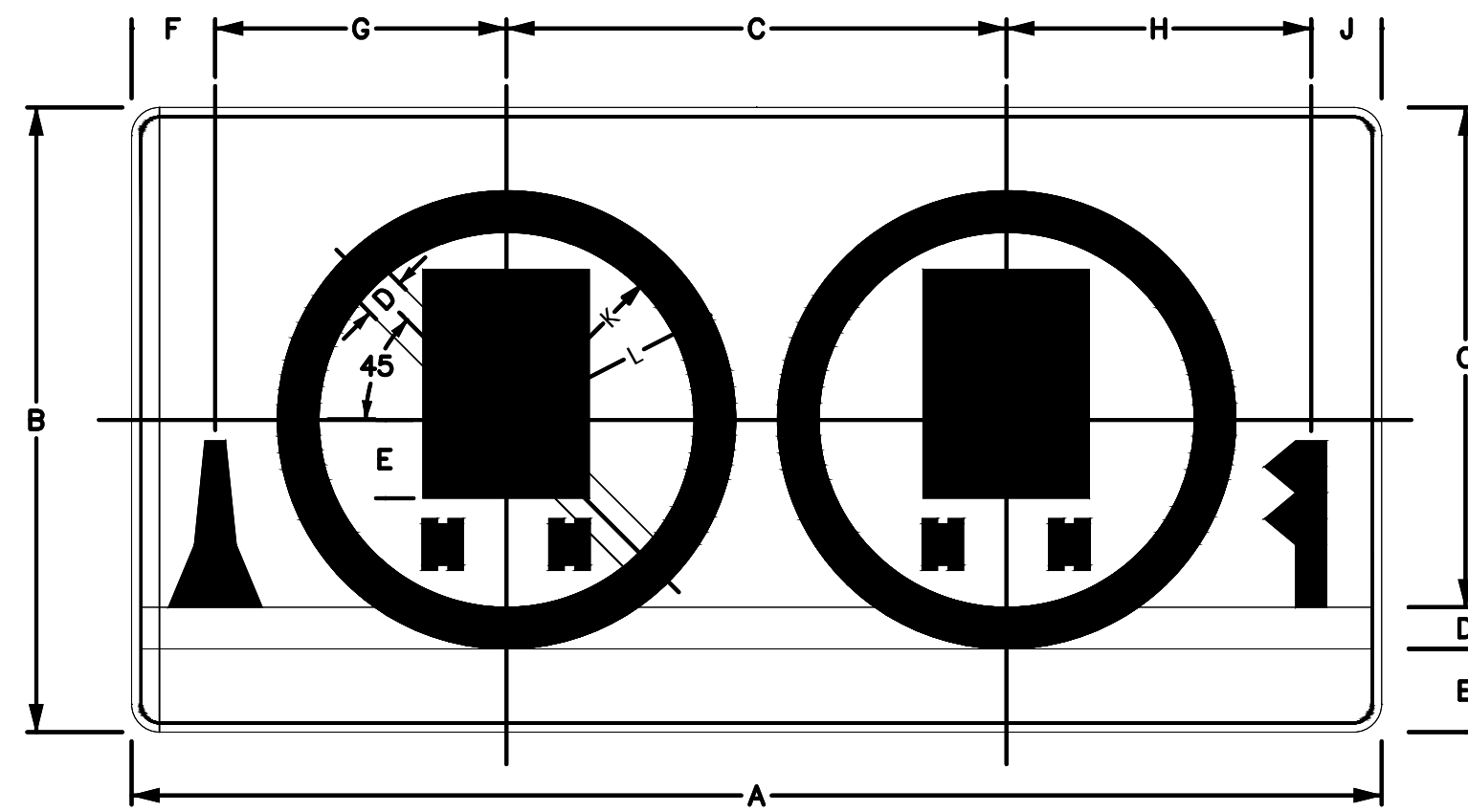

DIMENSIONS - IN												
SIGN SIZE A X B	C	D	E	F	G	H	J	K	L	MARGIN	BORDER	BLANK STD.
90" X 45"	36	3	6	6.1	20.9	21.9	5.1	13.5	16.5	0.8	1	---
120" X 60"	48	4	8	8.1	27.8	29.3	6.8	18	22	0.8	1	---

COLOR:

SYMBOL AND BORDER:
 BLACK (NON-REFLECTORIZED)
 LEFT CIRCLE WITH DIAGONAL: RED (REFLECTORIZED) - TYPE XI
 RIGHT CIRCLE: GREEN (REFLECTORIZED) - TYPE XI

BACKGROUND:
 WHITE (REFLECTORIZED) - TYPE XI

PTC-TBA

TRUCKS AND BUSES ALLOWED

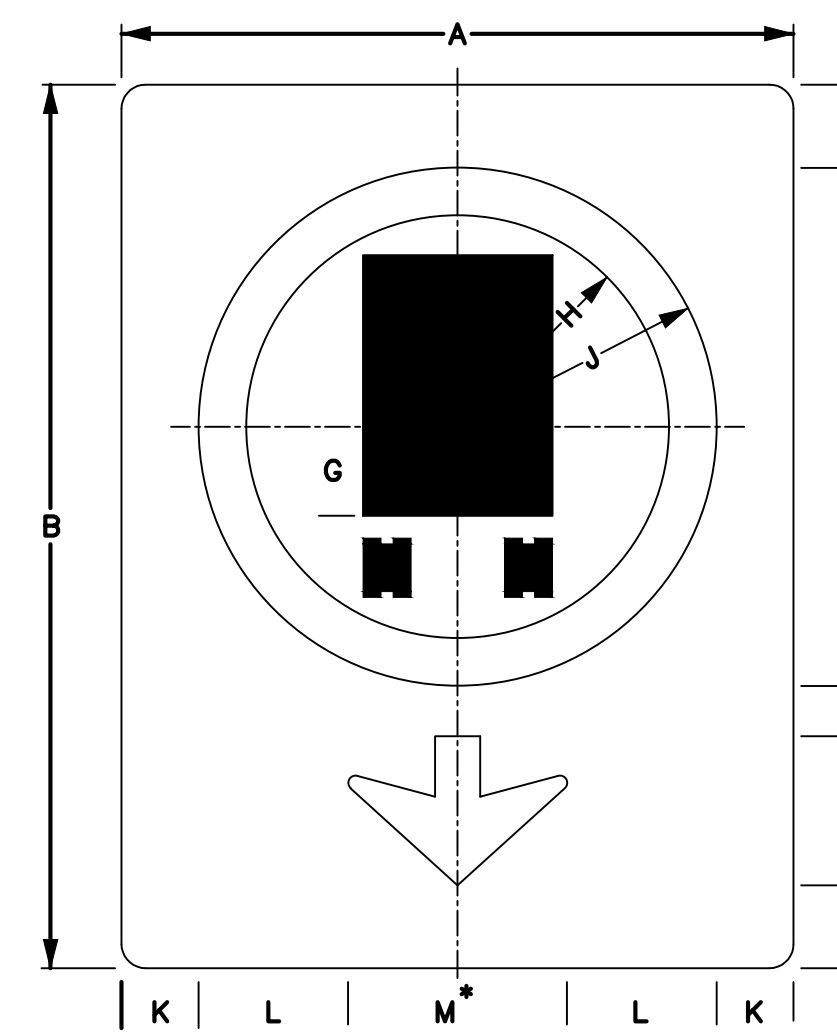

DIMENSIONS - IN													
SIGN SIZE A X B	C	D	E	F	G	H	J	K	L	M*	MARGIN	BORDER	BLANK STD.
66" X 84"	6.5	50	4.5	16.5	9	20	25	8	13	24	0.0	2	---

* TYPE D DOWN ARROW

COLOR:

SYMBOL AND BORDER:
 CIRCLE: GREEN (REFLECTORIZED) - TYPE XI

BACKGROUND:
 WHITE (REFLECTORIZED) - TYPE XI

PTC-TBP

TRUCKS AND BUSES PROHIBITED

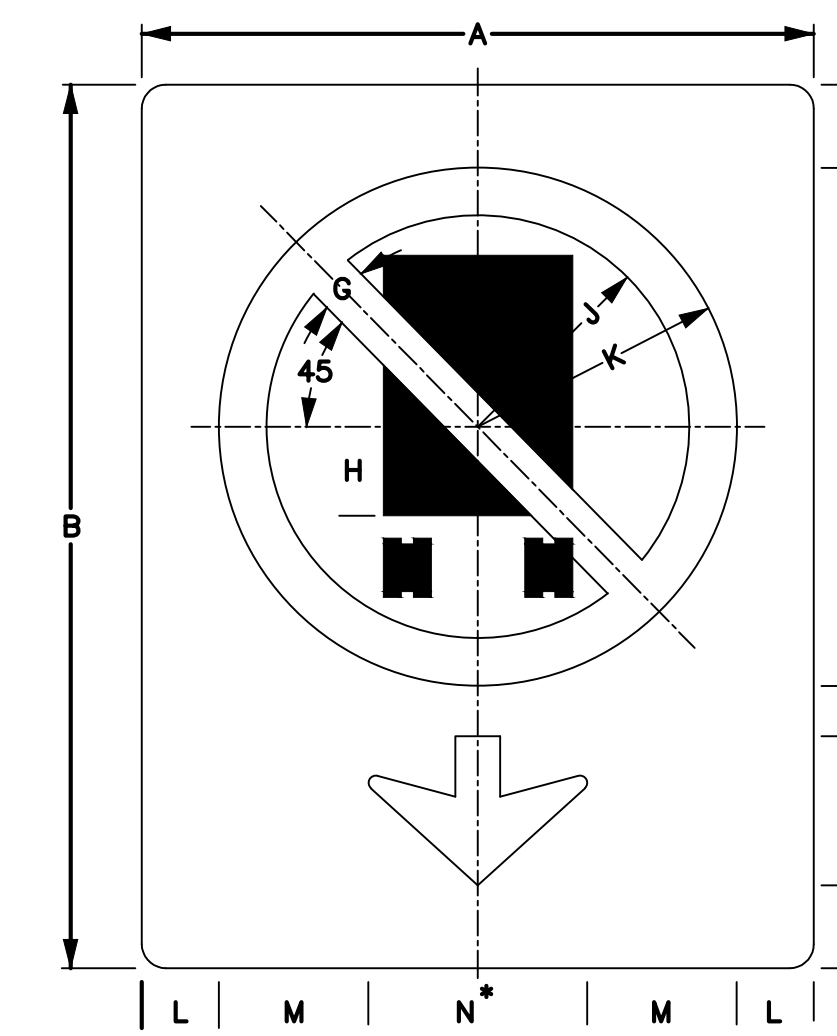

DIMENSIONS - IN														
SIGN SIZE A X B	C	D	E	F	G	H	J	K	L	M	N*	MARGIN	BORDER	BLANK STD.
66" X 84"	6.5	50	4.5	16.5	5	9	20	25	8	13	24	0.0	2	---

* TYPE D DOWN ARROW

COLOR:

SYMBOL AND BORDER:
 BLACK (NON-REFLECTORIZED)
 CIRCLE WITH DIAGONAL: RED (REFLECTORIZED) - TYPE XI

BACKGROUND:
 WHITE (REFLECTORIZED) - TYPE XI

PTC-TBLO

TRUCKS AND BUSES LEFT LANE ONLY SYMBOL SIGN

- (a) Justification. The Trucks and Buses Left Lane Only Symbol Sign (PTC-TBLO) may be used in construction zones where it is required to restrict trucks and buses to the left lane because of insufficient lane width or shoulder depth.
- (b) Placement. When used, this sign should be erected in advance of and within construction zones where trucks and buses are required to stay in the left lane only.

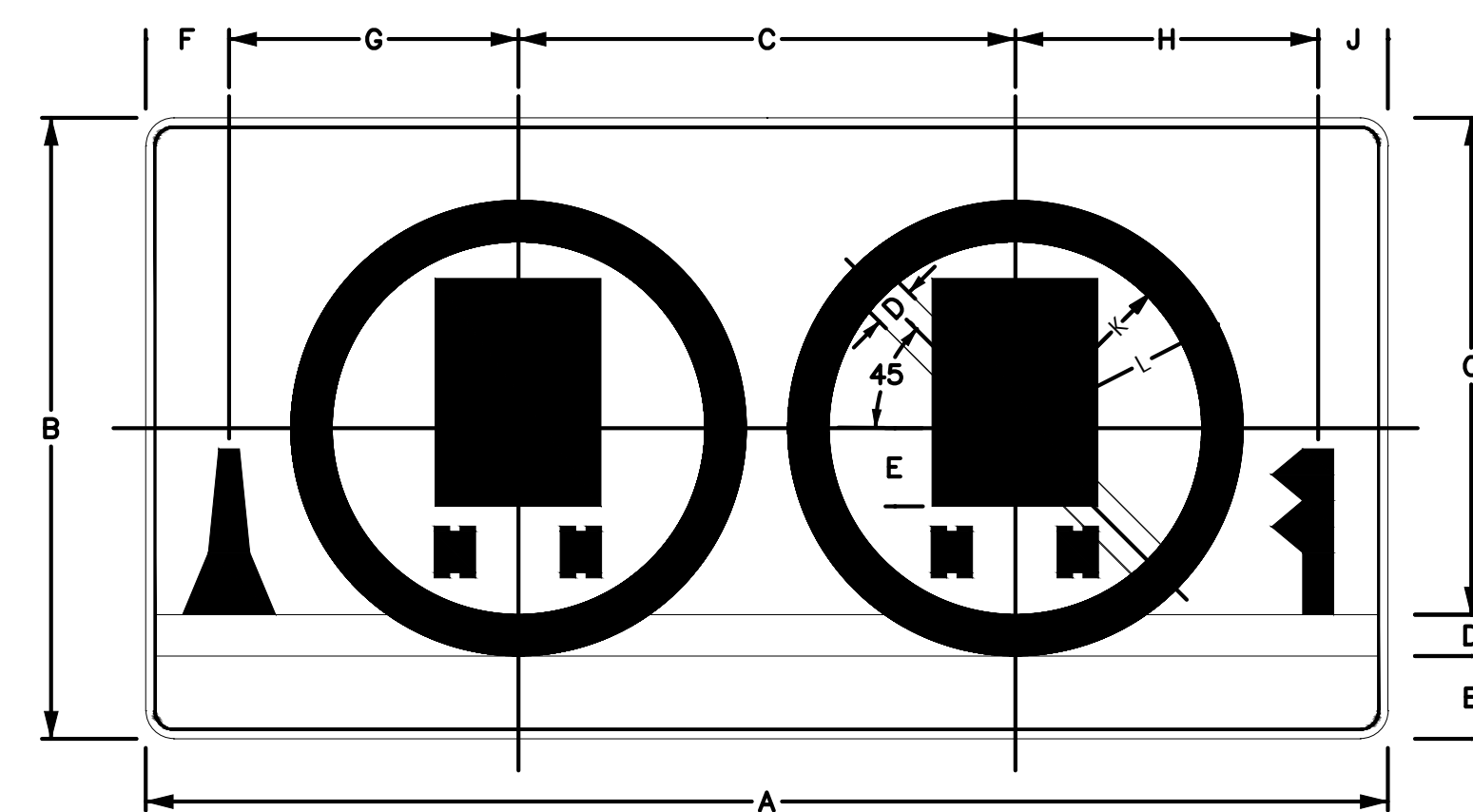

DIMENSIONS - IN												
SIGN SIZE A X B	C	D	E	F	G	H	J	K	L	MARGIN	BORDER	BLANK STD.
90" X 45"	36	3	6	6.1	20.9	21.9	5.1	13.5	16.5	0.8	1	---
120" X 60"	48	4	8	8.1	27.8	29.3	6.8	18	22	0.8	1	---

COLOR:

SYMBOL AND BORDER:
 BLACK (NON-REFLECTORIZED)
 LEFT CIRCLE: GREEN (REFLECTORIZED) - TYPE XI
 RIGHT CIRCLE WITH DIAGONAL: RED (REFLECTORIZED) - TYPE XI

BACKGROUND:
 WHITE (REFLECTORIZED) - TYPE XI

PTC-TBRO / PTC-TBLO

TRUCKS AND BUSES - SYMBOL DETAILS

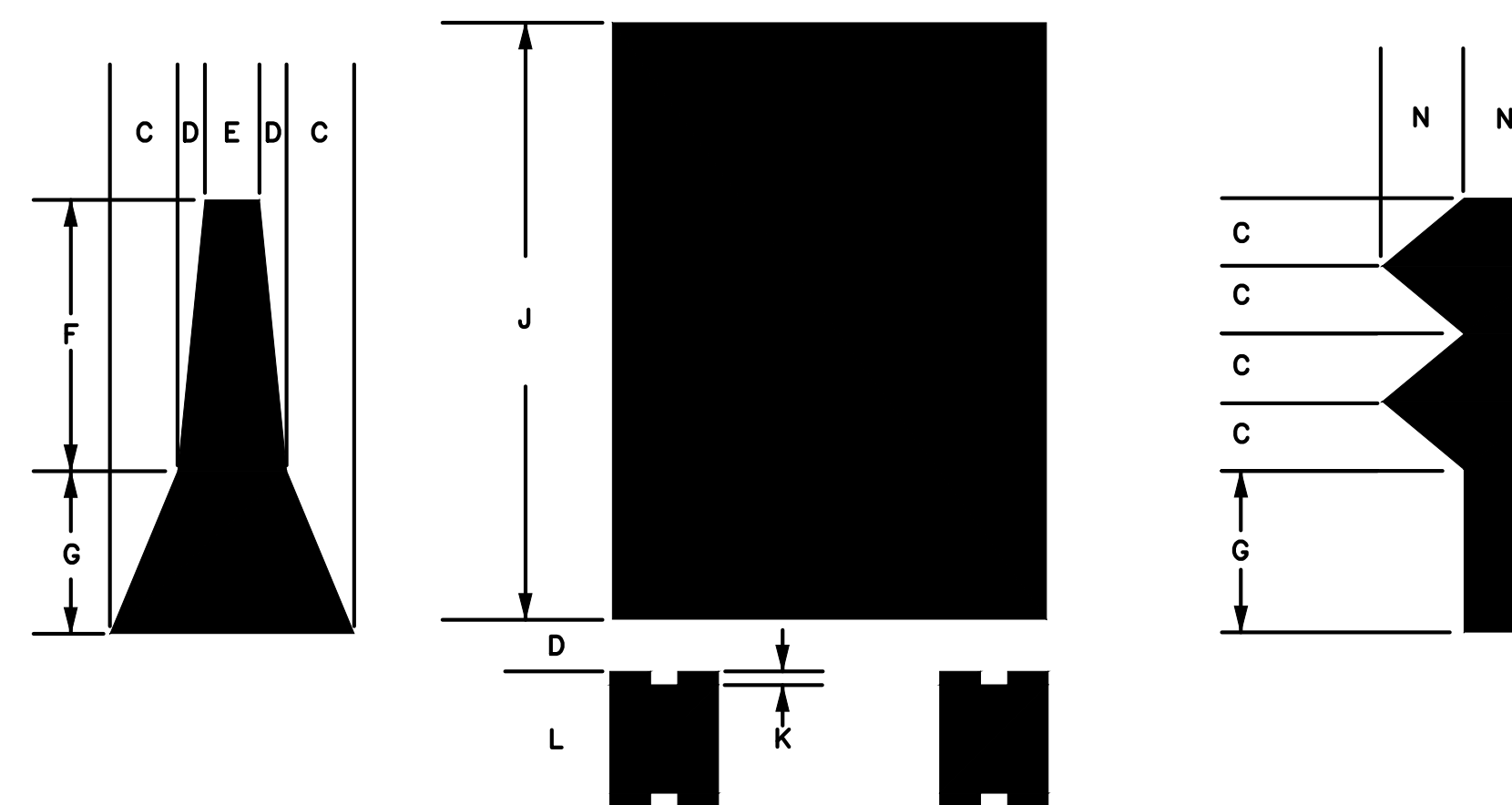

DIMENSIONS - IN											
SIGN SIZE A X B	C	D	E	F	G	H	J	K	L	M	N
90" X 45"	1.9	0.8	1.5	7.5	4.5	12	16.5	0.4	3.4	1.1	2.3
120" X 60"	2.5	1.0	2.0	10	6.0	16	22	0.5	4.5	1.5	3.0

PTC-TBA / PTC-TBP

TRUCKS BUSES ALLOWED OVERHEAD SYMBOL SIGN - SYMBOL DETAILS
 TRUCKS BUSES PROHIBITED OVERHEAD SYMBOL SIGN - SYMBOL DETAILS

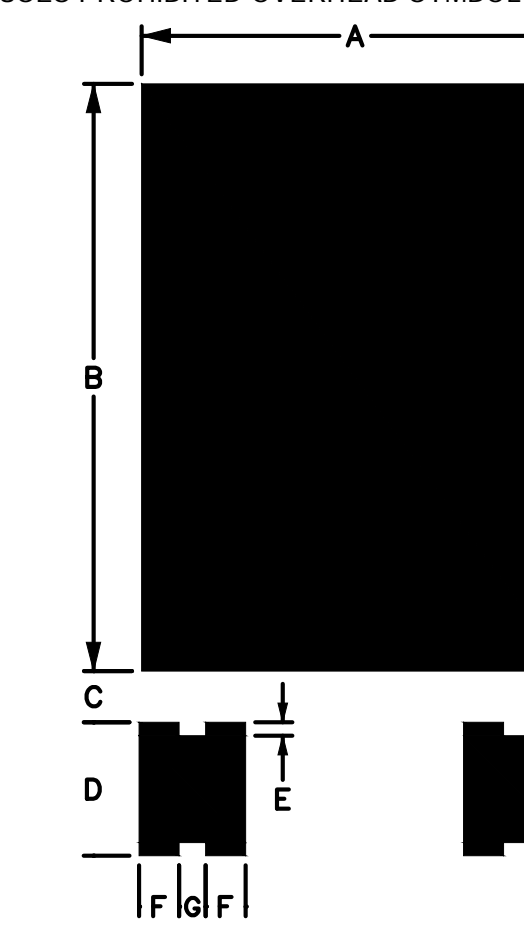

DIMENSIONS - IN						
A	B	C	D	E	F	G
18	25	2	5	0.6	1.7	1.1

- NOTES:
 1. ALL SIGN DIMENSIONS ARE IN INCHES, UNLESS OTHERWISE NOTED.
 2. SIGN SHOWN IS NOT TO SCALE.

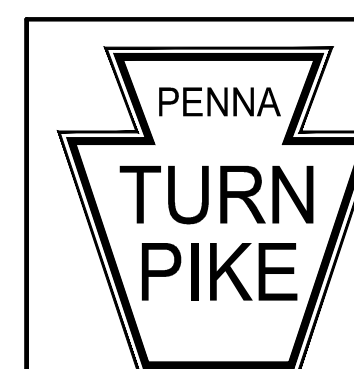

RECOMMENDED: MAY 3, 2024
[Signature]
 ASSISTANT CHIEF ENGINEER - DESIGN
 APPROVED: MAY 3, 2024
[Signature]
 CHIEF ENGINEER

CONSTRUCTION AND MAINTENANCE
 MAINTENANCE AND PROTECTION OF TRAFFIC
 SIGN FABRICATION

PENNSYLVANIA TURNPIKE COMMISSION
 STANDARD DRAWING

FILE NAME: PTS-960-2.dwg
 DRAWING TYPE: 5A

SHEET 2 OF 5

DATE: APRIL 2024

PTS-960

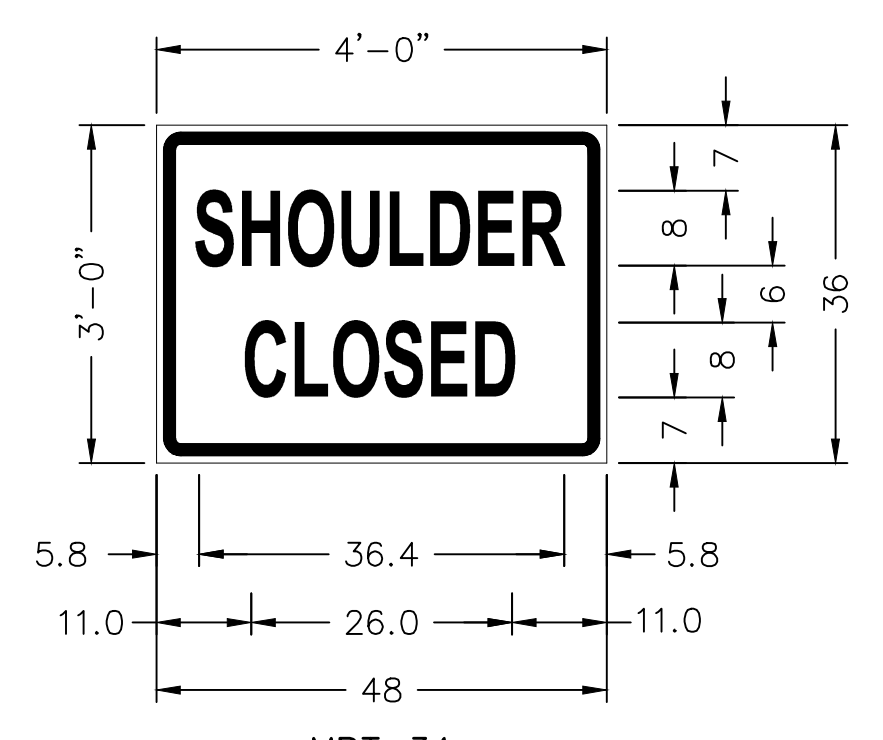

MPT-34
1.2" Border With 0.8" Radius
Black on Orange

8" LET. (SERIES B)	8" LET. (SERIES B)
5.8 -	11.0 -
4.9 - S	4.6 - C
4.9 - H	4.2 - L
5.1 - O	4.8 - O
4.8 - U	4.8 - S
4.2 - L	4.2 - E
4.9 - D	3.4 - D
4.2 - E	11.0 -
3.4 - R	48.0
5.8 -	
<u>48.0</u>	

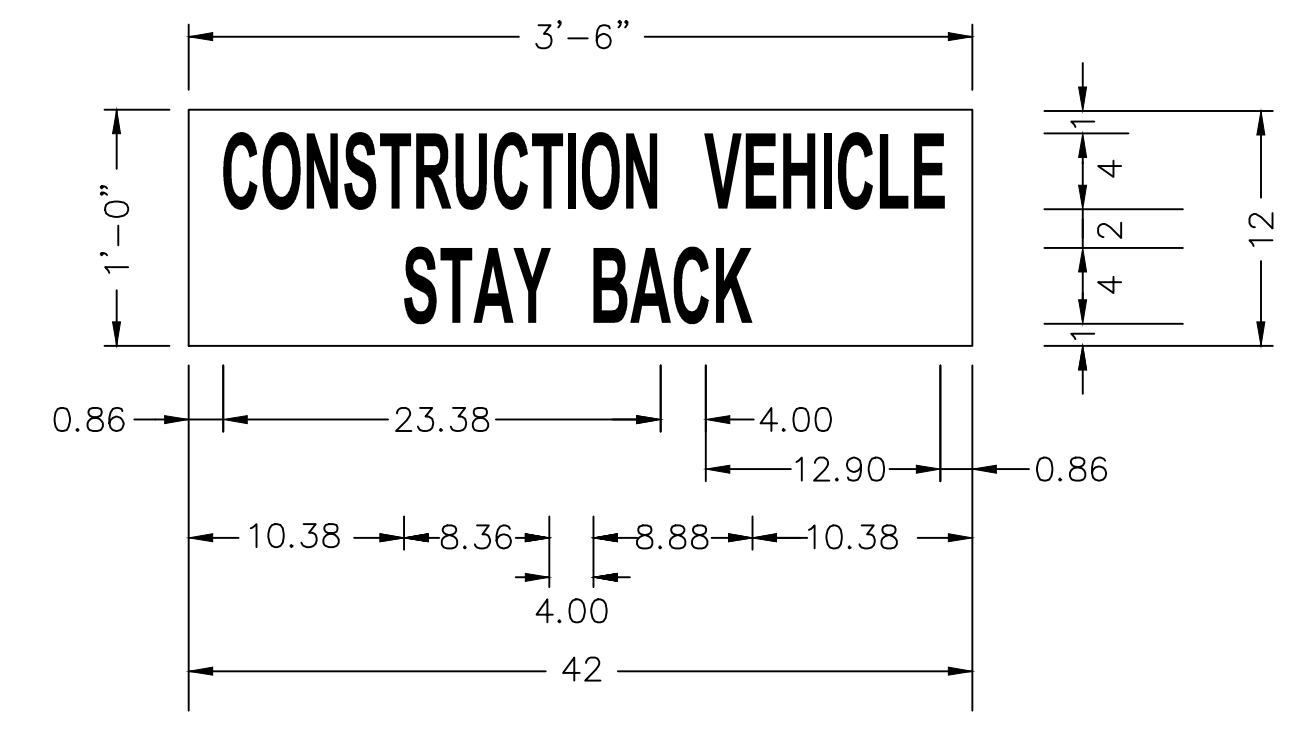

MPT-37
No border, Black on Orange;
"CONSTRUCTION VEHICLE" B 2K 60% spacing;
"STAY BACK" B 2K;

4" LET.		4" LET.	
0.86 -	4.00 -	10.38 -	4.00 -
2.10 - C	2.22 - V	2.04 - S	2.04 - B
2.30 - O	1.90 - E	1.76 - T	2.60 - A
2.10 - N	2.25 - H	2.40 - A	2.48 - C
1.92 - S	0.98 - I	2.16 - Y	1.76 - K
1.85 - T	2.17 - C		10.38 -
2.11 - R	1.86 - L		
2.17 - U	1.52 - E		
1.99 - C	0.86 -		
1.85 - T			
0.98 - I			
2.29 - O			
1.72 - N			
<u>42.0</u>			

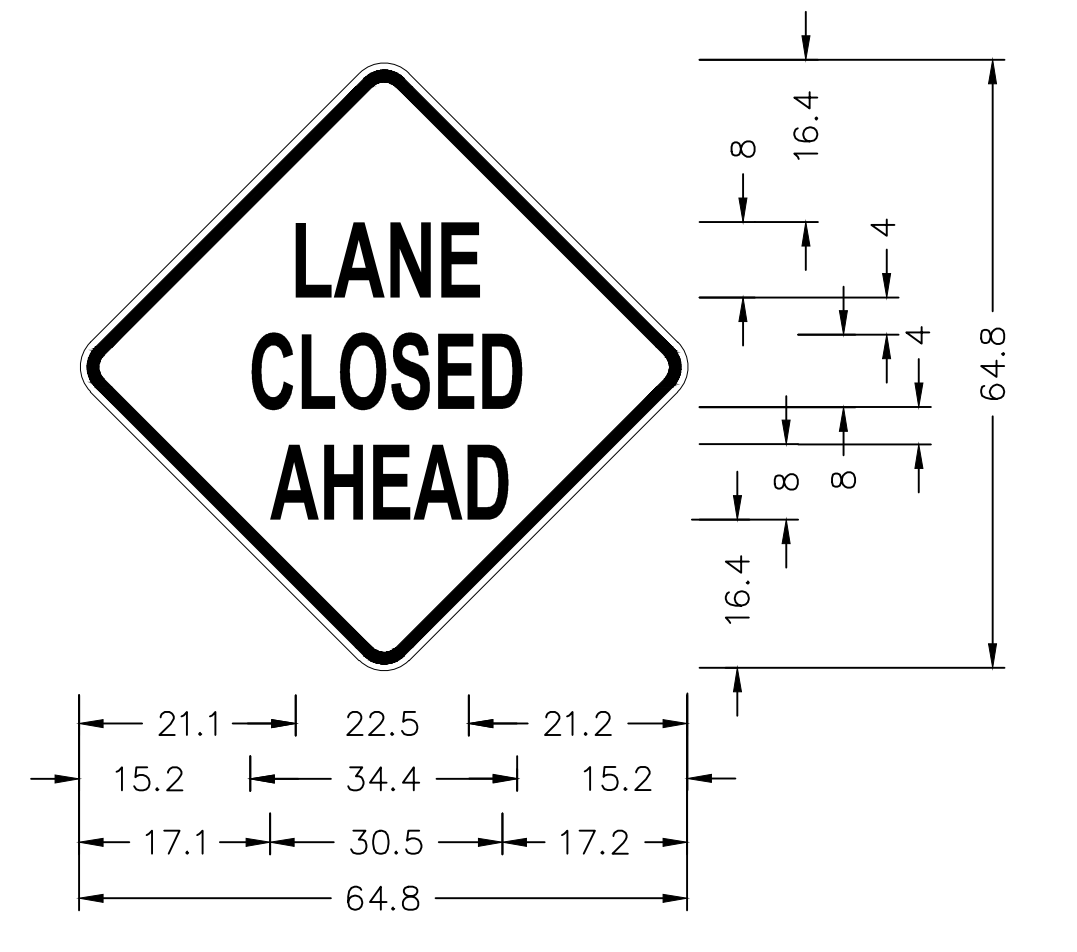

PTC-LCA

8" LET. (SERIES D)	8" LET. (SERIES D)	8" LET. (SERIES D)
21.1 -	15.2 -	17.1 -
5.0 - L	5.9 - C	7.1 - A
6.9 - A	5.4 - L	5.8 - H
5.7 - N	6.2 - O	5.2 - E
4.9 - E	6.1 - S	7.0 - A
21.2 -	5.4 - E	5.4 - D
64.8	5.4 - D	17.2 -
	15.2 -	64.8
	<u>64.8</u>	

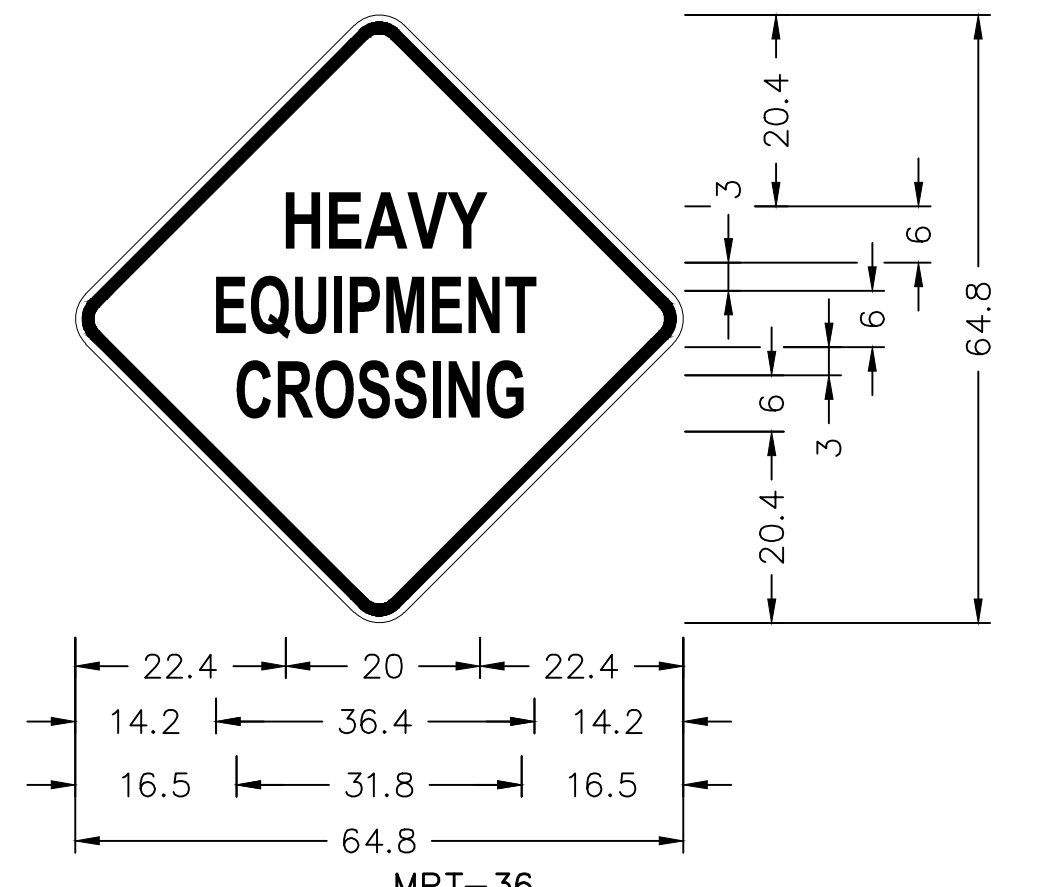

MPT-36
48" Across Sides, 0.8" Border, 0.4" Indent With 3.8" Radius
Black on Orange

6" LET. (SERIES C)	6" LET. (SERIES C)	6" LET. (SERIES C)
22.4 -	14.2 -	16.5 -
4.5 - H	4.0 - E	4.3 - C
3.7 - E	4.7 - Q	4.3 - R
4.1 - A	4.6 - U	4.4 - O
4.0 - V	2.1 - I	4.3 - S
3.7 - Y	4.5 - P	4.6 - S
22.4 -	5.2 - M	2.1 - I
64.8	4.0 - E	4.5 - N
	4.3 - N	3.3 - G
	3.0 - T	16.5 -
	14.2 -	64.8
	<u>64.8</u>	

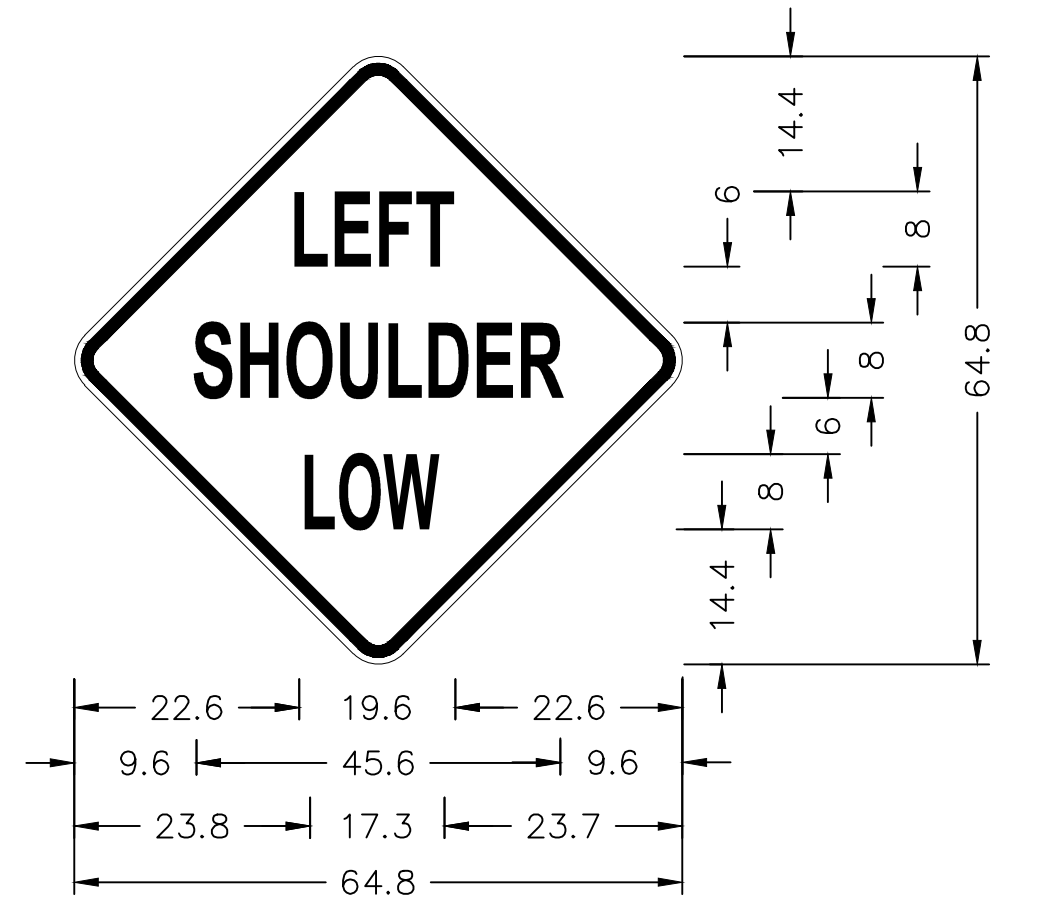

MPT-38
48" Across Sides, 0.8" Border, 0.4" Indent With 3.8" Radius
Black on Orange

8" LET. (SERIES C)	8" LET. (SERIES C)	8" LET. (SERIES C)
22.6 -	9.6 -	23.8 -
5.3 - L	6.0 - S	5.4 - L
5.4 - E	6.1 - H	5.9 - O
4.9 - F	6.3 - O	6.0 - W
4.0 - T	6.0 - U	23.7 -
22.6 -	5.4 - L	64.8
64.8	6.1 - D	
	5.3 - E	
	4.4 - R	
	9.6 -	
	<u>64.8</u>	

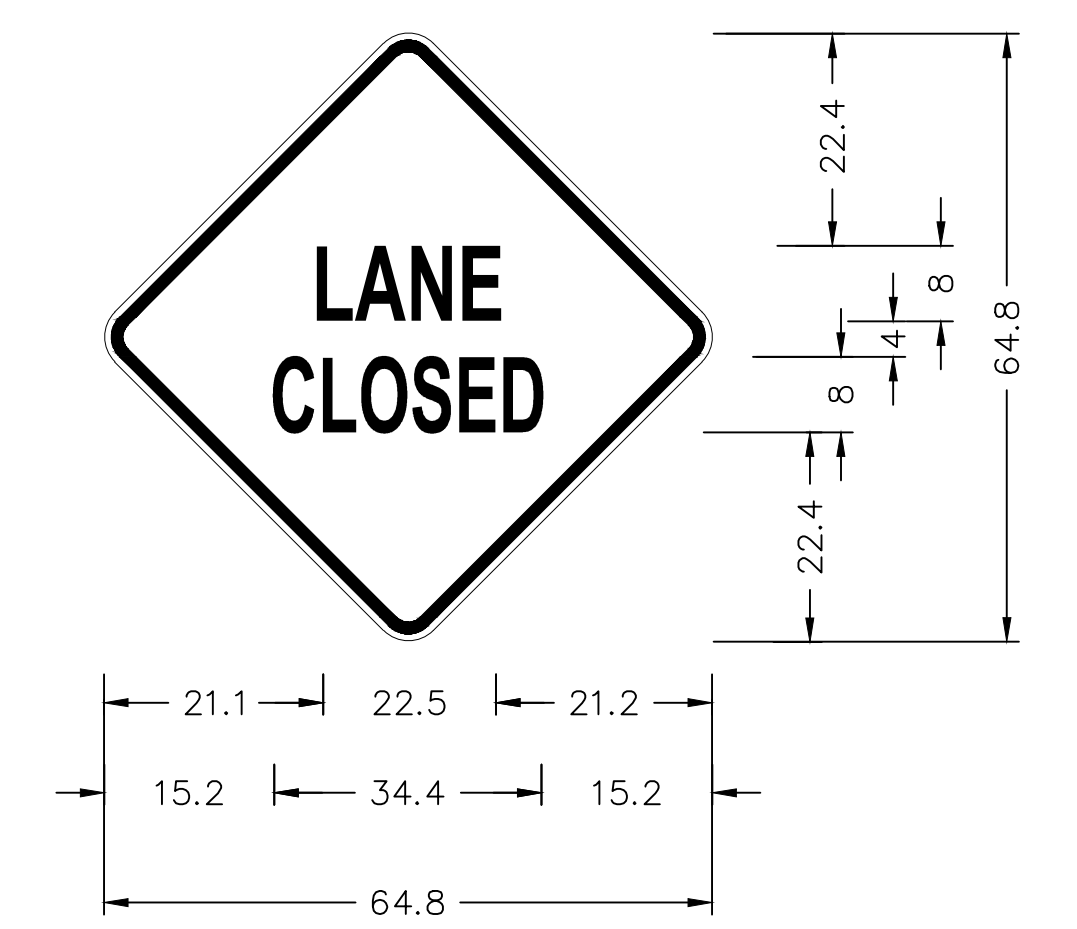

PTC-LC

8" LET. (SERIES D)	8" LET. (SERIES D)
21.1 -	15.2 -
5.0 - L	5.9 - C
6.9 - A	5.4 - L
5.7 - N	6.2 - O
4.9 - E	6.1 - S
21.2 -	5.4 - E
64.8	5.4 - D
	15.2 -
	<u>64.8</u>

NOTES:
1. ALL SIGN DIMENSIONS ARE IN INCHES, UNLESS NOTED OTHERWISE.
2. SIGN SHOWN IS NOT TO SCALE.

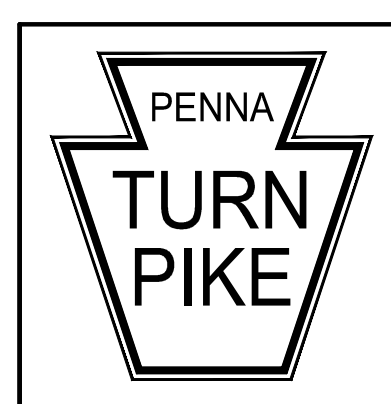



RECOMMENDED: MAY 3, 2024
[Signature]
ASSISTANT CHIEF ENGINEER - DESIGN
APPROVED: *[Signature]* MAY 3, 2024
CHIEF ENGINEER

CONSTRUCTION AND MAINTENANCE
MAINTENANCE AND PROTECTION OF TRAFFIC
SIGN FABRICATION

PENNSYLVANIA TURNPIKE COMMISSION
STANDARD DRAWING
FILE NAME: PTS-960-3.dwg
DRAWING TYPE: 5A
DATE: APRIL 2024
SHEET 3 OF 5
PTS-960

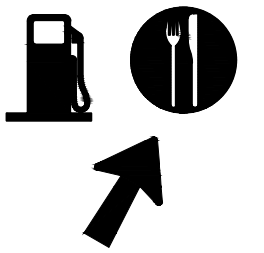
TABULATION OF MPT SIGNS

SIGN	SIZE	LEGEND	BACK-GROUND	COPY	BORDER	ARROWS
D12-14A	3' x 3'	EMERGENCY CELLULAR *11	BLUE	WHITE	WHITE	_____
EPO ID	3' x 2.5'	N-4	ORANGE	BLACK	BLACK	_____
MPT-01	3' x 4'	CROSSOVER 500 FT	ORANGE	BLACK	BLACK	_____
MPT-03	3' x 4'	CROSSOVER 1000 FT	ORANGE	BLACK	BLACK	_____
MPT-06	5' x 5'	EXIT 	GREEN	WHITE	WHITE	WHITE
MPT-08	5' x 5'		BLUE	WHITE	WHITE	WHITE
MPT-10	8' x 4'	TOLL PLAZA AREA CONSTRUCTION	ORANGE	BLACK	BLACK	_____
MPT-31	8' x 4'	NO SHOULDER NEXT __ MILES	ORANGE	BLACK	BLACK	_____

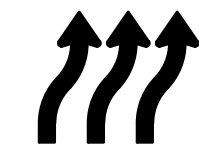
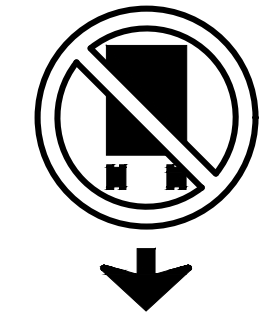
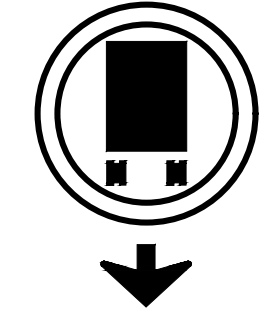
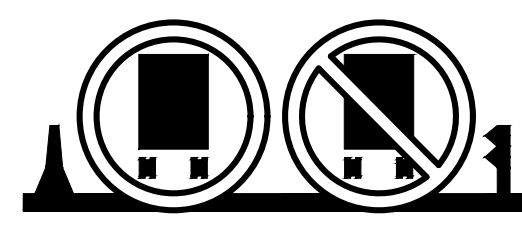
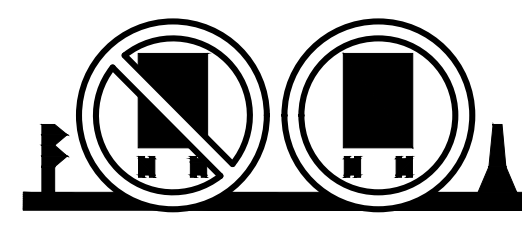
SIGN	SIZE	LEGEND	BACK-GROUND	COPY	BORDER	ARROWS
MPT-34	4' x 3'	SHOULDER CLOSED	ORANGE	BLACK	BLACK	_____
MPT-36	4' x 4'	HEAVY EQUIPMENT CROSSING	ORANGE	BLACK	BLACK	_____
MPT-37	3.5' x 1'	CONSTRUCTION VEHICLE STAY BACK	ORANGE	BLACK	_____	_____
MPT-38	4' x 4'	LEFT SHOULDER LOW	ORANGE	BLACK	BLACK	_____
W1-4CL	4' x 4'		ORANGE	BLACK	BLACK	BLACK
W1-4CR	4' x 4'		ORANGE	BLACK	BLACK	BLACK
PTC-LC	4' x 4'	LANE CLOSED	ORANGE	BLACK	BLACK	_____
PTC-LCA	4' x 4'	LANE CLOSED AHEAD	ORANGE	BLACK	BLACK	_____
PTC-TBP	5.5' x 7'		WHITE	BLACK	BLACK/RED(CIRCLE)	BLACK
PTC-TBA	5.5' x 7'		WHITE	BLACK	BLACK/GREEN(CIRCLE)	BLACK
PTC-TBLO	7.5' x 3.75' OR 10' x 5'		WHITE	BLACK	BLACK/GREEN(CIRCLE)/RED(CIRCLE WITH DIAGONAL)	_____
PTC-TBRO	7.5' x 3.75' OR 10' x 5'		WHITE	BLACK	BLACK/GREEN(CIRCLE)/RED(CIRCLE WITH DIAGONAL)	_____

GENERAL NOTES:

1. PROVIDE ALL OTHER SIGNS PER PENNDOT PUB. 236 AND SIZED AS INDICATED FOR EXPRESSWAYS AND INTERSTATES.
2. PROVIDE SIGNS WITH PENNDOT TYPE XI REFLECTIVE SHEETING MATERIAL. BLACK LEGEND AND BORDER IS NON-REFLECTIVE.
3. EXISTING MPT-08 MAY ONLY BE USED FOR THE REMAINDER OF THEIR SERVICEABLE LIFE.

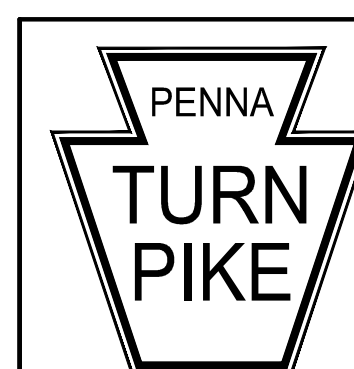

RECOMMENDED: MAY 3, 2024
[Signature]
 ASSISTANT CHIEF ENGINEER - DESIGN
 APPROVED: MAY 3, 2024
[Signature]
 CHIEF ENGINEER

**CONSTRUCTION AND MAINTENANCE
 MAINTENANCE AND PROTECTION OF TRAFFIC
 GENERAL NOTES AND TABULATION OF SIGNS**

**PENNSYLVANIA TURNPIKE COMMISSION
 STANDARD DRAWING**

FILE NAME: PTS-960-4.dwg	SHEET 4 OF 5
DRAWING TYPE: 5A	
DATE: APRIL 2024	PTS-960

ABCDEFGHIJK
 LMNOPQRSTU
 VWXYZ

1234567890
 @ % \$ #
 * () ! ?

\ / []
 ^ _ + -

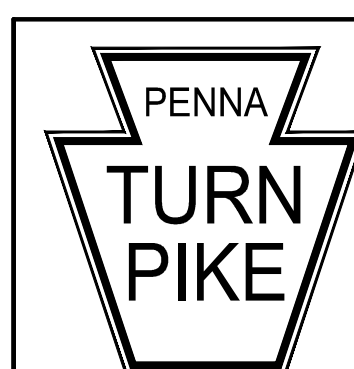

RECOMMENDED: MAY 3, 2024
[Signature]
 ASSISTANT CHIEF ENGINEER - DESIGN
 APPROVED: MAY 3, 2024
[Signature]
 CHIEF ENGINEER

CONSTRUCTION AND MAINTENANCE
 MAINTENANCE AND PROTECTION OF TRAFFIC
 PCMS CONDENSED FONT DETAILS

PENNSYLVANIA TURNPIKE COMMISSION
 STANDARD DRAWING

FILE NAME: PTS-960-5.dwg
 DRAWING TYPE: 5A

SHEET 5 OF 5

DATE: APRIL 2024

PTS-960